

Villa /showroom down light

LED 9W/12W | Anti-glare Reflector| UGR<9



DIWANIA TRIMLESS



specifications

material	Die-cast aluminium
finish/colour	black/silver/gold/chrome/light grey/orange red/white reflector
overall dimensions	Ø110 x H91mm
cut-out	Ø75mm
installation mount	ceiling recessed
beam angle	15°/24°/36°/60°
weight	0.3Kg
protection grade	IP20/IP65
labelling	CE



light source

type of source				CREE CXA1507
(mA)	(V)	(W)	(lm/W)	
200	36-40v	9W	90 @3000K	
300		12W		
colour rendering index (Ra)				(min90) 92
standard deviation color matching				SCDM2
average life Ta 25°				50000h L70 B10

product details

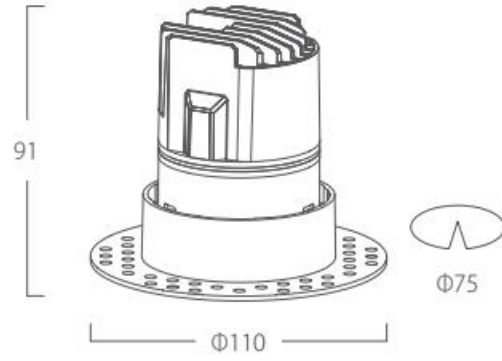
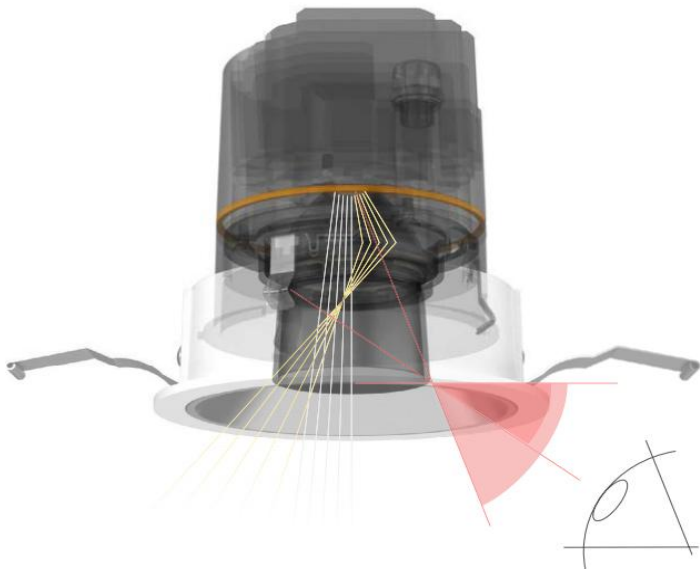

UNIT: mm

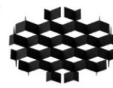

Honey comb



Clear Glass



Striped Glass



Frosted Softness



Sleeve

photometric

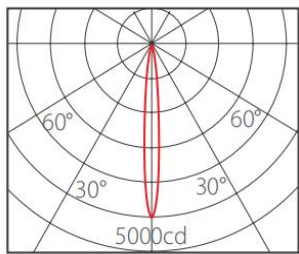

CREE 9W		15° 2700K Lens	
H(m)	L(m)	W(m)	E _{max}
1	0.22	0.22	4707
2	0.44	0.44	1177
3	0.65	0.65	523
4	0.87	0.87	294

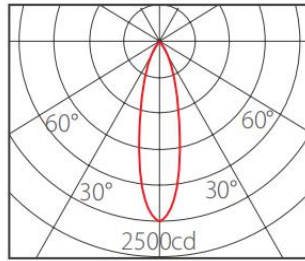

CREE 9W		24° 2700K Lens	
H(m)	L(m)	W(m)	E _{max}
1	0.41	0.41	2307
2	0.82	0.82	577
3	1.24	1.24	256
4	1.65	1.65	144

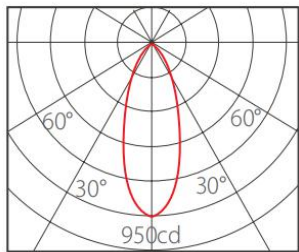

CREE 9W		36° 3000K Lens	
H(m)	L(m)	W(m)	E _{max}
1	0.67	0.67	902
2	1.35	1.35	226
3	2.02	2.02	100
4	2.67	2.67	56

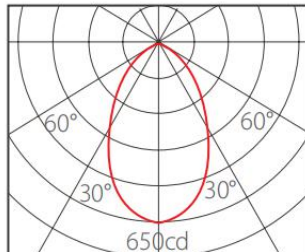

CREE 9W		60° 3000K Lens	
H(m)	L(m)	W(m)	E _{max}
1	0.94	0.94	407
2	1.88	1.88	102
3	2.82	2.82	45
4	3.76	3.76	25

item standard codes

spot type	wattage	luminous flux	CCT (k)	code no.
1 x 9W	9W	540lm	2700/3000/4000/5000	bu-DN1109175-9W
1 x 12W	12W	720lm	2700/3000/4000/5000	bu-DN1109175-12W

